

Legenda	
	Caixas Inspeção Esgoto Simples
	Caixas de Gordura
	Caixa Sifonada
	Curva 45° Longa para Esgoto Sanitário
	Curva 45° Longa Amarelo
	Curva 45° Curta Amarelo
	Curva 90° Curta-Culura
	Joelho 45°
	Lavatório Residencial com Sifão
	Pia de Cozinha Residencial com Sifão 50mm
	Ramais de Ventilação
	Tê Sanitário
	Vaso Sanitário com Curva 90°
	Junção (Y) 100 x 100
	Junção (Y) 100 x 50
	Junção (Y) 40 x 40

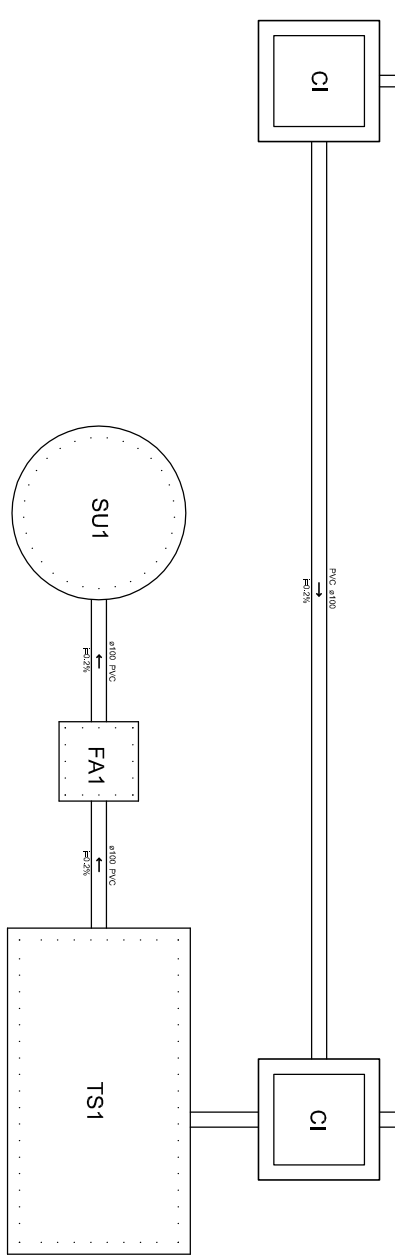
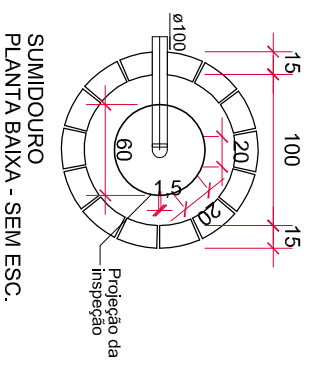
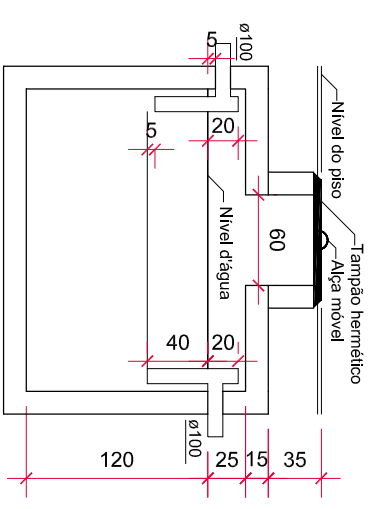
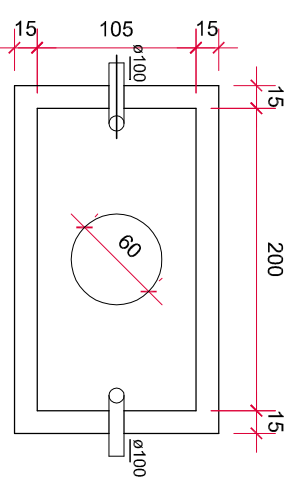
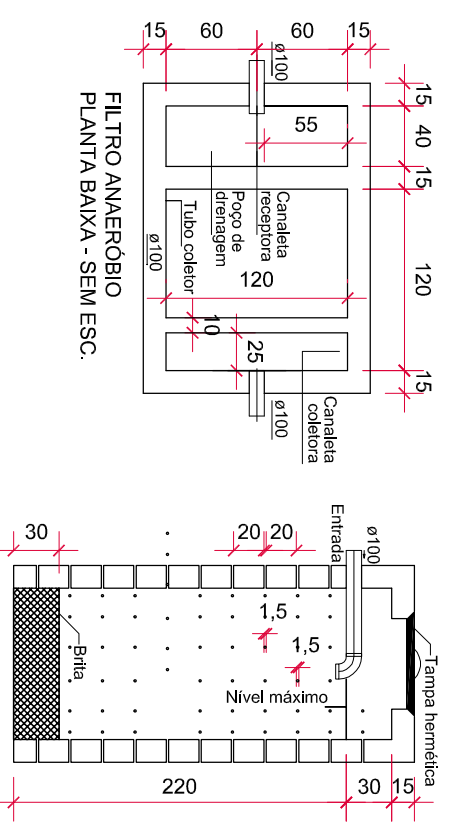
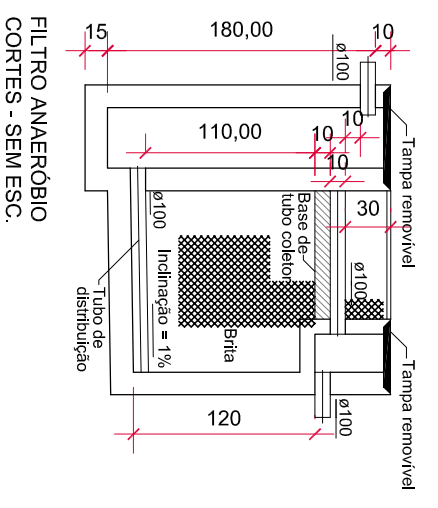
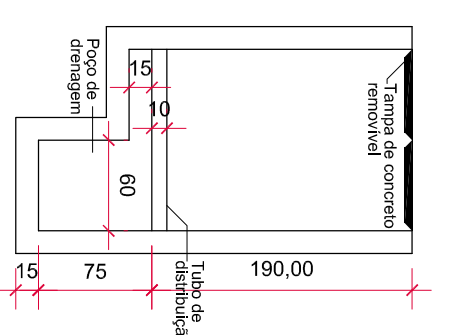

**PREFEITURA MUNICIPAL DE SÃO JOAQUIM**

MORADIA ECONÔMICA - MADEIRA - 50.40m<sup>2</sup>

PROJETO SANITÁRIO

PROPRIETÁRIO: XXXXX  
ENDEREÇO: XXX

RESPONSÁVEL TÉCNICO:

ÁREA	ESCALA	FOLHA	DATA
50,40m <sup>2</sup>	INDICADA	04/OX	XXXX/2018